

A2C9626040080 Injector Piezo Series Technical File**SKU: Y1L339626040080**

A2C9626040080 Injector Piezo Series Technical File**Content**

1. A2C9626040080 Injector Introduction.....	2
1.1. A2C9626040080 Injector Basic Information	2
1.2. A2C9626040080 Injector Common Part Number.....	2
1.3. A2C9626040080 Injector Matching Information	2
1.4. A2C9626040080 Injector Parameter.....	2
1.5. A2C9626040080 Injector Specifications and Dimensions.....	2
1.6. A2C9626040080 Injector Quality Control	3
1.7. A2C9626040080 Injector Customized Service	3
1.8. A2C9626040080 Injector Packing List and Package Size	3
1.9. A2C9626040080 Injector Testing Standard and Certificate	5
1.10. A2C9626040080 Injector Warranty Instructions.....	6
1.11. A2C9626040080 Injector Manufacturer	7
2. A2C9626040080 Injector Technical Support	7
2.1. A2C9626040080 Injector Part Number Location	7
2.2. A2C9626040080 Injector’s Application Scenarios.....	8
2.3. A2C9626040080 Injector Installation.....	8
2.4. Reasons for A2C9626040080 Injector Not Working Normally.....	9
2.5. Causes of A2C9626040080 Injector Being Damaged	9
2.6. A2C9626040080 Injector Technical Support Obtaining Methods.....	10
3. A2C9626040080 Injector Purchase and Delivery.....	10
3.1. A2C9626040080 Injector Purchase Payment Term.....	10
3.2. A2C9626040080 Injector Main Sales Markets	10
3.3. A2C9626040080 Injector Declaration Requirements.....	10
3.4. A2C9626040080 Injector Shipping Ways	10
3.5. A2C9626040080 Injector Lead time.....	10
3.6. A2C9626040080 Injector Logistics Time for Destination Out of China’s Areas.....	11
3.7. A2C9626040080 Injector Packing	11
4. A2C9626040080 Injector Storage Standard	12
5. Company Information.....	13
5.1. Company Introduction.....	13
5.2. Salesmen’s Contact Information.....	14
6. Copyright Statement.....	14

A2C9626040080 Injector Piezo Series Technical File

1. A2C9626040080 Injector Introduction

1.1. A2C9626040080 Injector Basic Information

Title	Original new Piezo Series A2C9626040080 Injector	Quality
SKU	Y1L339626040080	Original New

1.2. A2C9626040080 Injector Common Part Number

(1) Injector Exchange Information

Injector Part Number	Compatible Number	Remanufactured Number
A2C9626040080	5WS40539	/

(2) Injector Part Number Common Writing

A2C9626040080

1.3. A2C9626040080 Injector Matching Information

Vehicle Brand	Series	Car Model	Engine Model	Production Date	Power (KW)	Horse Power	Emission Standards	Manufacturer	Emissions (L)	Cylinder	Power Source (V)
Volkswagen	Piezo	Volkswagen	VI 1.6 TDI	2009 to Present	66-77	/	/	/	1.6	4	/

1.4. A2C9626040080 Injector Parameter

Adaptation System: Common Rail System

Injector Series: Piezo

Injector Type: Piezoelectric injector

Maximum System Pressure Supported: /

1.5. A2C9626040080 Injector Specifications and Dimensions

Injector Size: 21.5cm*4 cm *4 cm = 344cm³ (L*W*H=V)

Injector Net Weight: 0.55 kg

Gross Weight: 0.6 kg

Injector Quality: Original New

Package Size: 28cm*7 cm *7 cm = 1372 cm³

Injector Type: Piezoelectric injector

MOQ: 4 Pieces

1.6. A2C9626040080 Injector Quality Control

(1) Injector Testing

All Injector spare parts are tested for electrical characteristics, accuracy, high temperature, low temperature, withstand voltage, leakage, durability, and various working conditions.

(2) Injector Assembling

And the quality control of the injector production and installation process, our company strictly follows the standard product installation data and product installation steps to install, such as injector stroke test, injector solenoid valve tightening torque, and injector nozzle tightening torque.

(3) Injector Inspection

The factory inspection of the injector is undergone full inspection, random inspection, and batch inspection three inspections. Different brands of test benches are used to test the same injector for a total of no less than three times for factory inspection, and the injector installation testing environment are progressed in dust-free workshop.

1.7. A2C9626040080 Injector Customized Service

(1) Injector Customized Service: Meet the customized needs of OEM manufacturers for shell lettering, logo engraving, injector internal packaging, injector external packaging and labels customized, etc.

		
<p>Injector house lettering and QR code</p>	<p>Injector solenoid valve engraving</p>	<p>Injector box and label</p>

(2) Injector Customized Service Requirements:

The purchased of customized injector are not less than **10 pieces**.

Customized injector packages no less than **1000 pieces**.



When the customized products involve the need of specify logo, the OEM manufacturer needs to provide trademark authorization and the sample of logo image file.

▲ Once the customized injector is sold, it cannot be returned or exchanged if there is no quality problems.

1.8. A2C9626040080 Injector Packing List and Package Size

(1) Injector Spare Parts List

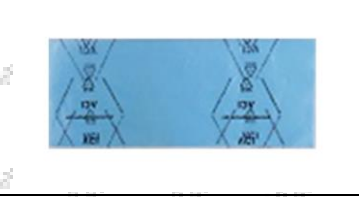
No.	1	2	3
Image			
Name	Injector	O-Ring	Gasket

Descriptio n	Injector part number: A2C9626040080	Ensure to meet the standard of the sealing performance between the injector and the engine	Made of brass, used to ensure the tight fit between the injector cap end and the engine
No.	4	5	6
Image			
Name	Injector Protective Cover Cap	VCI Anti-rust Bag	Bubble Bag
Descriptio n	Protect nozzle holes from being polluted and blocked	Prevent injector from rusting	Prevent the injector from being damaged by external forces
No.	7	8	9
Image		/	/
Name	Injector Packing Box	/	/
Descriptio n	Place injector and injector accessories	/	/

⚠ Minors are forbidden to use the injector assembly, O-ring, gasket, protective cover, injector house protective cover, solenoid valve protective cover, VCI anti-rust bag, and air bubble bag to avoid personal injury.

⚠ O-ring and gasket are disposable installation accessories, and need to be replaced for re-installation.

⚠ The nozzle protective cover, injector house cover and solenoid valve cover are recyclable accessories that can be reused.

⚠ VCI anti-rust bag and bubble bag are non-degradable materials, please dispose of them properly after using.

⚠ The injector and the installation parts should be coated with appropriate sealing oil during installation.

(2) Injector Box Size



No.	Name	Injector Package Size (cm)
1	Injector Box	28*7*7

1.9. A2C9626040080 Injector Testing Standard and Certificate

Shumatt can provide the factory quality inspection test report of each injector to ensure that each injector delivered meets the engine performance indicators.

BOTEN
测试报告
4.05.2019 10:42:09

承办单位: _____
 电话: _____ 地址: _____
 传真: _____ 检测人: _____
 客户地址: _____
 电话: _____ 检测单位: _____
 传真: _____ 客户姓名: _____
 检测描述: _____

零件名称: 喷油器
 型号-零件号: _____
 检测项: _____

检测结果

检测编号: C9626040080-0511

检测项名称	检测结果	标准范围	判定结果	
IGN TEST:	32	4-5	30.0-1.0	✓
Back:	32	4	15.0-25.0	✓
WARM:	32	17.0-18.0	0.0-0.5	✗
Max:	215	218.0-244	0.0-0.5	✓
TL:	284	282.0-285	0.0-0.5	✓
EL:	141	137.0-148	0.0-0.5	✓
VE:	62	4.0-16	0.0-0.5	✓

检测日期: _____
检测地点: _____

1.10. A2C9626040080 Injector Warranty Instructions

(1) Product Warranty Conditions and Instructions

It is necessary to provide pictures, videos, or test reports detected by the injector inspection equipment when the injector is abnormal during use as evidence to feed back to the salesman.

Abnormal conditions are properly explained such as: 1.Smoke, 2. Engine shake, 3. Difficulty starting the engine, 4. Engine noise, 5. oil leakage etc.

(2) Injector Warranty Coverage

Within 15 days after customer receives the [A2C9626040080](#) injector, if there is a performance failure and the product has no appearance damage, customer can choose to replace it or repair it;

If the [A2C9626040080](#) injector has performance problems during the warranty period (6-12 months), and it is confirmed that it is product problems after testing, you can contact our salesmen to replace the same model or a reworked product with the same performance for free;

If the injector house has obvious scratches, it can only be repaired and it will be returned as it is if the product is confirmed to be fault-free.

▲ Tips: For products not covered by warranty, Shumatt can provide paid maintenance services. For products after paid repaired, the same performance problem will have a free warranty period within 3 months from the date of repairing.

(3) Injector Out of Warranty Coverage

Mob/WhatsApp: +86 13410541523

Email : ruby@shumatt.com

© 2024 Shenzhen Shumatt Technology Co., Ltd

Tel: +8675523215133

Website : www.shumatt.com

- The warranty period has expired.
- Injector working failure caused by high temperature, high pressure, humidity, rain and snow, saline-alkali land, earthquake, and used in abnormal environment.
- Customer disassembles or repairs the injector personally resulting in damage to the injector.
- Injector damage caused by man-made reasons (throwing, strong magnetic field magnetization, set fire).
- Injector working failure or injector damaged caused by non-injector design, technology, manufacturing, quality and other issues.
- Injector working failure due to system pressure exceeding system approved pressure.
- Injector working failure caused by system voltage exceeding approved voltage.
- Injector working failure caused by impurities (water, lead, aluminum powder, iron powder, sulfide) in the system fuel exceeding the standard requirements.
- Injector working failure caused by not installing according to the tightening torque specified in the vehicle engine maintenance manual (the tightening torque is too large or too small).
- Injector working failure caused by not following the installation angle specified in the vehicle engine maintenance manual.
- Injector working failure caused by not following the cleaning requirements specified in the vehicle engine maintenance manual.
- Injector working failure caused by failure to replace consumable parts as specified in the vehicle engine maintenance manual.
- Injector working failure caused by not complying with the intake system fit clearance and exhaust system fit clearance requirements specified in the vehicle engine maintenance manual.
- Failure to replace the consumable parts and the fitting clearance of the oil inlet system pipeline and the injector connection in accordance with the fuel intake system specified in the vehicle engine maintenance manual.

1.11. A2C9626040080 Injector Manufacturer

Injector manufacturer: Shenzhen Shumatt Technology Co., Ltd

2. A2C9626040080 Injector Technical Support

2.1. A2C9626040080 Injector Part Number Location

1) E.g.: The injector part number location is as follows

No.	Name
A	brand, logo, part number, series number
B	part number

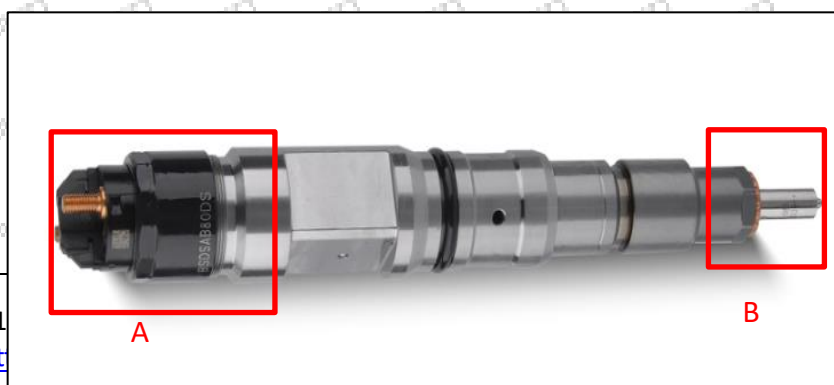

Mob/WhatsApp: +86 1

Email : ruby@shumat

© 2024 Shenzhen Shumatt Technology Co., Ltd

2.2. A2C9626040080 Injector's Application Scenarios

Common rail system is an oil supply method refers to the diesel oil from the fuel tank sucked out by the gear pump through the oil-water separator and the gear pump to diesel fine filter, high-pressure pump, common rail pipe, and fuel injector, all together with the closed-loop fuel supply system composed of sensors and ECU that completely separates the generation of injection pressure and the injection process from each other.

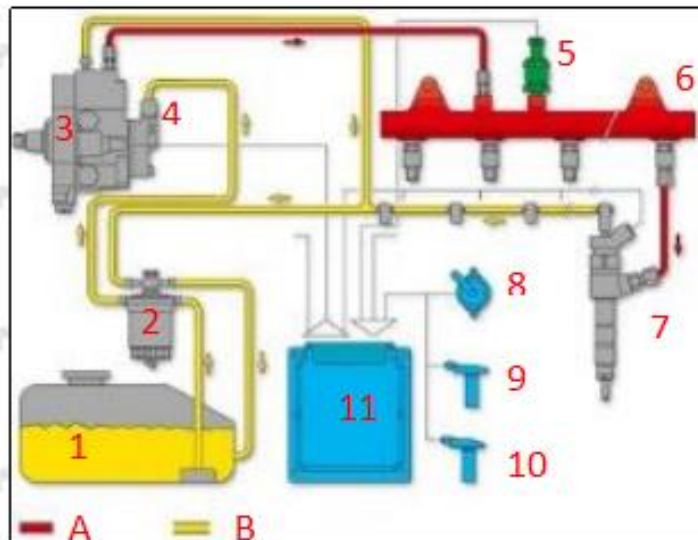

No.	Name	No.	Name	No.	Name	No.	Name
1	Tank	5	Common Rail Pressure Sensor	9	Engine Crankshaft Sensor	A	High Pressure Oil Circuit
2	Diesel Filter	6	Common Rail Pipe	10	Camshaft Sensor	B	Low Pressure Oil Circuit
3	High-Pressure Pump	7	Injector	11	ECU Electronic Control Unit	/	/
4	Fuel Gear Pump	8	Accelerator Pedal	/	/	/	/

2.3. A2C9626040080 Injector Installation

(1) A2C9626040080 Injector Installation Precautions:

⚠ The replacement of the injector must strictly follow the electrical system, the approved pressure of the low-pressure fuel intake system, the approved pressure of the high-pressure fuel circuit system, and fuel system replacement consumables requirements (including the low-pressure fuel circuit system filter and the high-pressure fuel circuit) specified in the vehicle engine maintenance manual,

⚠ Replacement of wearing parts of the fuel system, cleaning requirements for the connection between the fuel system and the injector, the fitting clearance of the injector connection, the installation angle and tightening torque of the injector, the fitting clearance of the intake system, and the fitting clearance of the

exhaust system to ensure the service life of the engine and the normal operation of the injector.

- ⚠ When installing the injector on the engine, it is necessary to clean the engine block, cylinder head and other parts connected to the injector, and ensure that there is no dust, carbon deposits, water, rust spots, etc.
- ⚠ When installing the injector, apply lubricant between the injector, sealing gasket and O-ring.
- ⚠ When installing the injector on the engine, please carefully check the components related to the installation of the injector, such as the injector pressure plate, screw, injector rod and other accessories are not deformed, and install it in strict accordance with the operation steps of the engine maintenance manual.
- ⚠ It is forbidden to operate the bare injector for a long time in an environment with serious dust pollution and corrosion to iron products.
- ⚠ It is forbidden to operate the bare injector for a long time in a strong magnetic field environment.

2.4. Reasons for A2C9626040080 Injector Not Working Normally

- (1) There is air in the oil circuit of the engine fuel system.
 - (2) Vehicle oil pump oil supply system is not normal.
 - (3) Engine common rail system oil leakage or pressure limiting valve damage.
 - (4) There is a short circuit, cutting out and poor contact in the wiring harness connected to the injector of the vehicle.
 - (5) The long-term placement of the injector causes the anti-rust oil to solidify, and the internal components are stuck or the oil holes are blocked.
- ⚠ Before installing, carefully check whether other components in the common rail system except the injector are damaged so as to prevent the injector from not working properly after being replaced.

2.5. Causes of A2C9626040080 Injector Being Damaged

- (1) The operator does not operate properly according to engine maintenance manual during disassembly or installation, resulting in damage to the injector.
- (2) The fuel oil used for the vehicle does not meet the standard cause damage to the injector, such as: the water content in the fuel oil exceeds the standard, iron powder, aluminum powder, sulfide impurities exceed the standard, etc.
- (3) The engine is not regularly maintained according to the engine maintenance manual (please refer to the vehicle maintenance manual for the maintenance mileage). For example, failure to replace the lubricating oil of the engine system for a long time will cause abnormal wear of the engine, excessive exhaust gas volume or a large amount of carbon deposits inside the engine. The filter is not replaced during maintenance or the replaced filter cannot reach the original filter standard. all above reasons can cause damage to the injector.
- (4) The abrasion of the oil pump produces iron powder and aluminum powder enter the injector and cause damage to the injector.
- (5) The deformation and abrasion of fuel tank result in iron powder or aluminum powder entering the injector and causing damage to the injector.
- (6) The injector is damaged due to replacement or adjustment of the relevant parts of the injector. For

example, the valve clearance does not meet the standard after the engine is repaired, the replacement or modification of the wiring harness connected to the injector fails to meet the original standard.

- (7) The engine is overheated and overloaded for a long time working results in damage to the injector.
- (8) The injector will be damaged naturally at the end of its working life.
- (9) The injector is magnetized (injector parts' magnetic exceeded) causing the injector to not work properly.

▲ Before replacing the injector, please check the engine parts carefully according to the engine maintenance manual to avoid the injector being damaged again after replacement.

2.6. A2C9626040080 Injector Technical Support Obtaining Methods

- (1) Injector Technical File , visit <http://shumatt.com> to get the technical file.
- (2) Injector Technical Videos

Facebook: Visit <https://www.facebook.com/hison.li> to get the technical videos, constantly follow can get more information.

YouTube: https://www.youtube.com/channel/UCByvYBx7VjV_mAfxh_Hu-aw to get the technical videos, constantly follow can get more information.

Shumatt: Visit <http://shumatt.com> to get the technical videos.

- (3) Injector Information Query Software

TruckBook Parts EPC APP, Android/Apple App Store download and install, visit <http://shumatt.com> to get the download and installation tutorial

- (3) Search The injector test data through TruckBook Parts EPC APP.

3. A2C9626040080 Injector Purchase and Delivery

3.1. A2C9626040080 Injector Purchase Payment Term

Payment Terms: T/T, PayPal, Alipay, WeChat

Please contact our salesmen for specific payment information.

3.2. A2C9626040080 Injector Main Sales Markets

Injector main sales markets: Asia, Europe, North America, South America, Africa etc.

3.3. A2C9626040080 Injector Declaration Requirements

Shumatt can assist customers to provide the following documents for import customs clearance: contract, invoice, packing list, bill of lading, insurance policy, certificate of origin, etc.

3.4. A2C9626040080 Injector Shipping Ways

Destination in China areas: SF Express, Debon Express, the corresponding logistics company can be provided according to customer requirements in special cases.

Destinations out of China's areas: DHL, UPS, FedEx, TNT air, ocean or other shipping methods required by customers.

3.5. A2C9626040080 Injector Lead time

Lead time: Send out within 3 – 7 working days after receiving payment (Except for special products and

special cases) .

3.6. A2C9626040080 Injector Logistics Time for Destination Out of China's Areas

DHL Logistics Time :

Country or Region of Departure	Hong Kong, China	Other Countries or Regions of Asia	Australia and New Zealand	Europe	America	Other Countries
China's Mainland	7 Days	7 Days	8 Days	8 Days	8-12 Days	7-10 Days

UPS Logistics Time: Country or Region of Departure: China's Mainland

Country of Destination	Estimated Arrival Time	Country of Destination	Estimated Arrival Time	Country of Destination	Estimated Arrival Time
Japan	3 Days	UK	5-7Days	Egypt	5-7 Days
Turkey	5-7 Days	Singapore	3 Days	Switzerland	5-7 Days
Bahrain	5-7 Days	Latvia	7-10 Days	New Zealand	7-10 Days
Sri Lanka	5-7 Days	Thailand	3 Days	Austria	5-7 Days
Romania	5-7 Days	Vietnam	3-5 Days	Estonia	5-7 Days
Malaysia	3-5 Days	Israel	5-7 Days	Mexico	7-10 Days
France	5-7 Days	America	5-7 Days	United Arab Emirates	5-7 Days
Italy	5-7 Days	Netherlands	5-7 Days	Bengal	7-10 Days
Lebanon	5-7 Days	Philippine	3-5 Days	Greece	7-10 Days
South Korea	3 Days	Spain	5-7 Days	Myanmar	5-7 Days
Canada	5-7 Days	Germany	5-7 Days	Saudi Arabia	7-10 Days
Portugal	5-7 Days	Australia	5-7 Days	South Africa	7-10 Days
Denmark	5-7 Days	Belgium	5-7 Days	Ukraine	7-10 Days
India	7-10 Days	Qatar	7-10 Days	Poland	5-7 Days
Indonesia	3-5 Days	Morocco	7-10 Days	Pakistan	7-10 Days
Kuwait	7-10 Days				

⚠ The logistics time is for reference only , subjects are according to the actual arrival.

3.7. A2C9626040080 Injector Packing

Domestic express packaging: Usually wrapped in waterproof scotch tape, such as picture No.1.

International express packaging: Wrapped with waterproof yellow tape After wrapping the black protective film, such as picture No. 2.

Pallet Shipping: Use fumigation free and recycling trays that meet export requirements, and use white wrapping protective film to wrap and bind with cable ties for the outside, such as picture No. 3, also, the products can be packaged according to customers' requirements.

⚠ The packing tray is made of plastic and can be recycled.

⚠ Transparent tape, yellow tape, black wrapping protective film, white wrapping protective film are non-degradable materials, please dispose of them properly.

⚠ Minors are prohibited from using transparent tape, yellow tape, black wrapping protective film, and

white wrapping protective film to avoid personal injury.



Pic No. 1

Domestic express packaging:
Wrapped with Transparent tape



Pic No. 2

International express packaging:
Wrapped with yellow tape after wrapping
black protective film



Pic No. 3

Pallet Shipping: Use pallet that meet export requirements, and use white wrapping protective film to wrap and bind with cable ties

4. **A2C9626040080 Injector Storage Standard**

(1) **Choose a suitable storage place**

The warehouse and cargo yard where the injector is stored should be kept clean and dry, and away from the factory buildings that generate harmful gases and dust; do not mix with acid, alkali, salt and other substances; the storage place should have a good drainage system; the cargo yard should be flattened with gravel or furnace ash etc. to enhance the water permeability of the surface layer to keep the reservoir area dry.

(2) **Strict requirements of warehousing**

Strict inspections should be carried out when the injectors are put into storage, the surface cleaning work should be done well to remove water traces, oil stains, ash and other dirt, remove the rust and do anti-rust treatment in time. Packaged injectors must be protected from damage.

(3) **Keep the warehouse dry and preventing moisture**

The relative humidity is usually below 70% for the injectors placed in the room, and the corrosion of the injectors is significantly reduced.

The injectors must be stored in the warehouse, and they are forbidden to store in the same warehouse with commodities with high water content.

(4) Stack Properly

After the injector is exposed to rain, the corrosion rate will increase significantly. The purpose of sealing is to isolate the injector from rainwater and humid air, so the warehouse window should be checked in time to avoid rainwater entering the warehouse

If the injector package is damaged, it should be repaired or replaced; when the package is damp, the packaging material should be dried; if the original anti-corrosion and oil applied at the factory is found to be damaged or dried up, it should be cleaned and re-applied oil in time.

- ⚠ It is forbidden to leave the injector exposed in the air for a long time.
- ⚠ It is forbidden to store acid, alkali, salt and other substances together with the injector.
- ⚠ The unpacked injector must be rust-proof during secondary storage.

5. Company Information



5.1. Company Introduction

Chinese Name: 深圳市舒马特科技有限公司

English Name: Shenzhen Shumatt Technology Co., Ltd

📞 **Mob Phone/WeChat:** +86-13410541523

📞 **HK Telephone:** +852-67653519

📞 **Telephone:** +86-755-23215133

Mob/WhatsApp: +86 13410541523

Email : ruby@shumatt.com

© 2024 Shenzhen Shumatt Technology Co., Ltd

Tel: +8675523215133

Website : www.shumatt.com

 **Email:** ruby@shumatt.com

 **Website:** www.shumatt.com

 **Shenzhen Office:** 11-12, Floor 14, Building 13, Qinchengda Building, Exit A, Honglang North Subway Station, Bao'an District, Shenzhen, China's Mainland

 **Shenzhen Office:** Exit C, Qiao Touxu Metro Station, NO. 66 Chongqing Road, Fuhai Avenue, Bao'an District, Shenzhen, China Mainland

 **Hong Kong Office:** Jianfa Street Industrial Zone, Tuen Mun, New Territories, Hong Kong, China

 **After-sales Service Address:** Please contact our salesmen to obtain and provide the corresponding product maintenance reasons (Reference: [1.10. A2C9626040080 Injector Warranty Instructions](#))

5.2. Salesmen's Contact Information

No.	Name	WeChat/WhatsApp	Email
1	Ruby	+86-13410541523	ruby@shumatt.com
2	Ivy	+86-18025299821	sales@shumatt.com
3	Rebecca	+86-18025349821	sales01@shumatt.com
4	Janny	+86-18028749821	sales02@shumatt.com
5	Sam	+86-13316859821	Sales8@shumatt.com
6	Natalie	+86- 18938945856	sales15@shumatt.com
7	Ada	+86-1342286353	sales5@shumatt.com
8	Hison Li	+86-18318811871	web@shumatt.com
9	Mecca	+86-18938948618	sales11@shumatt.com
10	Eric	+86 18319033618	sales3@shumatt.com
11	Wayne (Joaquín en español)	+86-13316959821	wayne@shumatt.com
12	Sylvia	+86 18312499884	sales6@shumatt.com

Visit <http://shumatt.com> to obtain the latest information of salesmen

PS: Shumatt's salesmen's emails are all end with @shumatt.com

6. Copyright Statement

The copyright of any contents (including but not limited to parameters, data, text, charts, images, sounds or videos, etc.) provided in "A2C9626040080 Injector Piezo Series Technical File" belong to Shenzhen Shumatt Technology Co., Ltd. Without the prior written permission of Shenzhen Shumatt Technology Co., Ltd., you are not allowed to modify any contents in "A2C9626040080 Injector Piezo Series Technical File" in any way. At the same time, any conditions to spread, repost, display the contents of "A2C9626040080 Injector Piezo Series Technical File" should indicate that the cited article is from Shenzhen Shumatt Technology Co., Ltd., Any actions failure to follow above conditions to use "A2C9626040080 Injector Piezo Series Technical File" will violate the "Copyright Law of the People's Republic of China" and other laws and regulations and the provisions of relevant international conventions.

Mob/WhatsApp: +86 13410541523

Email : ruby@shumatt.com

© 2024 Shenzhen Shumatt Technology Co., Ltd

Tel: +8675523215133

Website : www.shumatt.com