

0928400605 Metering Valve Technical File

SKU: G1Z210928406005

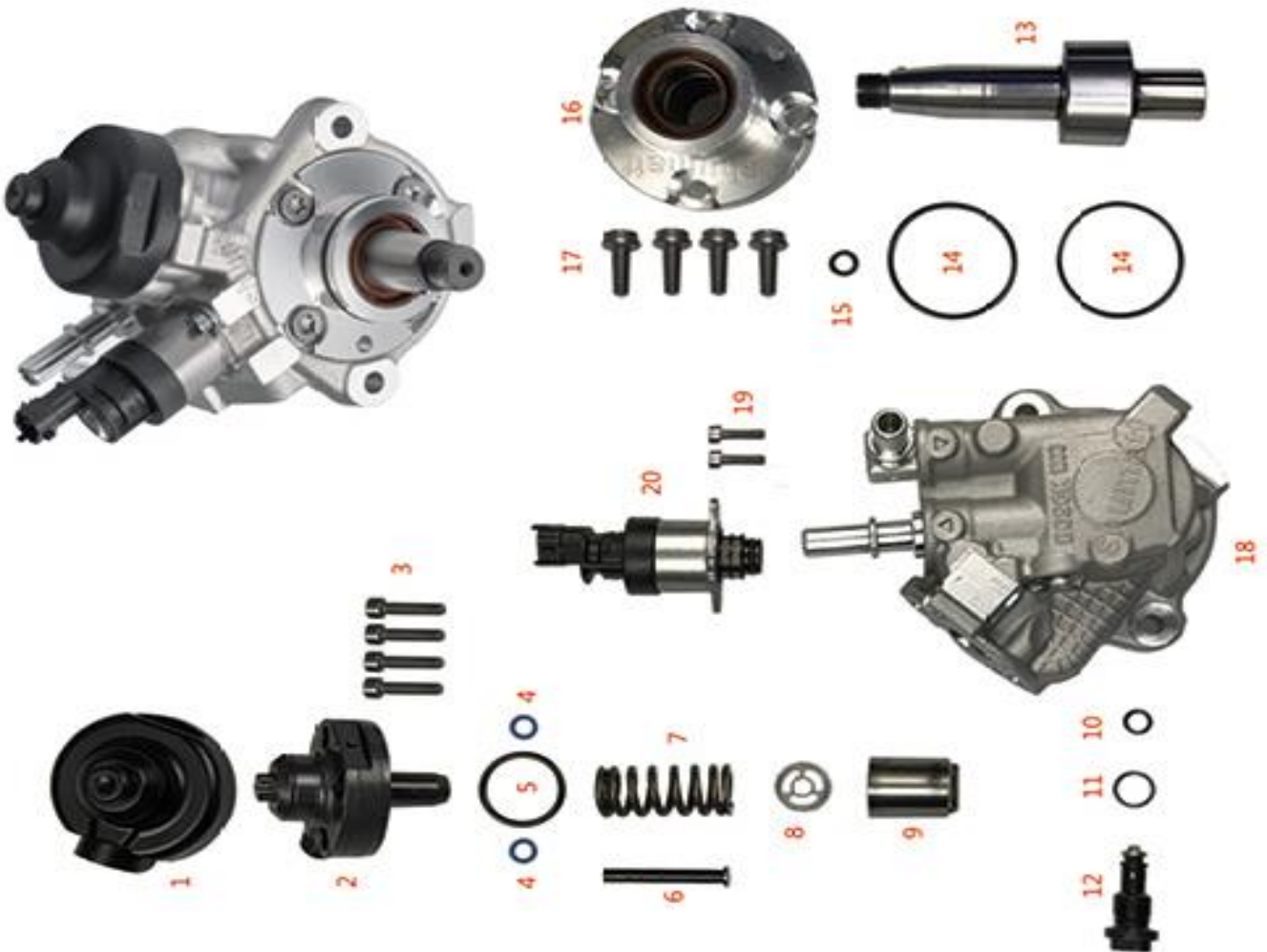

0928400605 Metering Valve Technical File

Content

1. 0928400605 Metering Valve Introduction.....	3
1.1. 0928400605 Metering Valve Basic Information	3
1.2. 0928400605 Metering Valve Application to Fuel Pump Information	3
1.3. 0928400605 Metering Valve Specifications and Dimensions.....	3
1.4. 0928400605 Metering Valve Quality Control	3
1.5. 0928400605 Metering Valve Customized Service	4
1.6. 0928400605 Metering Valve Spare Parts & Packing List	4
1.7. 0928400605 Metering Valve Warranty Instructions.....	5
1.8. 0928400605 Metering Valve Manufacturer	6
2. 0928400605 Metering Valve Technical Support	6
2.1. 0928400605 Metering Valve Technical Support Obtaining Methods	6
3. 0928400605 Metering Valve Purchase and Delivery.....	6
3.1.0928400605 Metering Valve Purchase Payment Terms	6
3.2.0928400605 Metering Valve Main Sales Markets	6
3.3.0928400605 Metering Valve Declaration Requirements.....	7
3.4.0928400605 Metering Valve Shipping Ways	7
3.5.0928400605 Metering Valve Lead time.....	7
3.6.0928400605 Metering Valve Logistics Time for Destination Out of China’s Areas.....	7
3.7.0928400605 Metering Valve Packing	7
4. 0928400605 Metering Valve Storage Standard	8
5. Company Information.....	9
5.1. Company Introduction.....	9
5.2. Sales-men’s Contact Information.....	10
6. Copyright Statement.....	10

0928400605 Metering Valve Technical File

1. 0928400605 Metering Valve Introduction

1.1. 0928400605 Metering Valve Basic Information

Title	China Made New 0928400605 Metering Valve
SKU	G1Z210928400605

1.2. 0928400605 Metering Valve Application to Fuel Pump Information

(1) 0928400605 Metering Valve Application to Car Model Information

Metering unit Part Number	Car Model	OE Number	OE Number
0928400605	/	/	/

(2) 0928400605 Metering Valve Application to Fuel Pump Part Number Information

Fuel Pump Series	Fuel Pump Part No.	OE Number	Car Model	Engine Model
/	/	/	/	/

(3) 0928400605 Metering Valve Part Number Common Written

0928400605, 0 928 400 605, 0928 400 605, 0928400 605, 0 928 400605, 0 928400605, 0 928400 605

1.3. 0928400605 Metering Valve Specifications and Dimensions

Metering Valve Size: 8cm*6 cm *6 cm

Metering Valve Box Size: 10 cm * 8 cm * 6 cm

Metering Valve Package Size: 12 cm *10 cm

Metering Valve Net Weight: 0.20kg

Metering Valve Gross Weight: 0.22kg

Metering Valve Quality: China Made New Metering Valve

Metering Valve MOQ: 4 pieces

1.4. 0928400605 Metering Valve Quality Control

(1) Metering Valve Testing

All parts of the metering valve have undergone precision testing, high temperature testing, low temperature testing, withstand pressure testing, leakage testing, durability testing, and various working conditions testing.

(2) Metering Valve Inspection

The factory inspection of the metering valve is undergone three inspections: full inspection, random inspection, and batch inspection. Different brands of test benches are used to test the same fuel pump metering for more than three times for factory inspection, and the metering valve 's installation and testing environment are progressed in dust-free workshop.

(3) Metering Valve Installation

When assembling the metering valve, Shumatt strictly assembles in accordance with the standard metering valve technical indicators to ensure that each metering valve complies with factory standards and

usage standards.

1.5. 0928400605 Metering Valve Customized Service

(1) Metering Valve Customized Service: Meet the customized needs of OEM manufacturers for metering unit’s lettering, package, and label customized, etc.

	
<p>Neutral Lettering</p>	<p>Shumatt Anti-Rust Bag</p>
	
<p>Shumatt White Label</p>	<p>Shumatt Neutral Brown Box</p>

(2) Metering Valve Customized Service Requirements:



Customized metering valve packages are no less than 100 pieces.

The purchase of customized metering valves is no less than 100pieces.

Customized products involve the need of specify logo, the OEM manufacturer needs to provide trademark authorization and the sample of logo image file.

▲ **Once the customized metering valve is sold, it cannot be returned or exchanged if there is no quality problem.**

1.6. 0928400605 Metering Valve Spare Parts & Packing List

No.	1	2
<p>Image</p>		
<p>Name</p>	<p>Metering Valve</p>	<p>Shumatt Anti-Rust Bag</p>

Description	Part number: 0928400605	Prevent the metering valve from rusting.
No.	3	4
Image		/
Name	Shumatt Neutral Brown Box	/
Description	Protect the metering valve from being damaged	/

- ▲ Minors are prohibited from using the metering valve, metering valve anti-rust bag, metering valve box to avoid personal injury.
- ▲ Metering valve box is recyclable and can be reused.
- ▲ VCI anti-rust bag is non-degradable materials, please dispose them properly after use.

1.7. 0928400605 Metering Valve Warranty Instructions

(1) Metering Valve Warranty Conditions and Instructions

It is necessary to provide pictures, videos of metering valve or test reports of metering valve inspection equipment as evidence to feed back to the salesman.

Metering valve abnormal conditions are properly explained such as: 1.Black smoke, 2. Engine shake, 3. Difficulty starting the engine, 4. Engine noise, 5. oil leakage etc.

Above problems also may cause by the incorrect installation of metering valve, if they are confirmed to be product's problems after tested by Shumatt, it is within the warranty coverage.

(2) Metering Valve Warranty Coverage

After customers receive the **0928400605** metering valve within 15 days, if there is a performance failure and the product has no appearance damage, customer can choose to replace it;

If the **0928400605** metering valve has performance problems during the warranty period (6-12 months), and it is confirmed to be product's problems after being tested, you can contact our salesmen to replace the same model or a reworked product with the same performance for free;

If the metering valve has obvious scratches, it can only be returned as it is if the product is confirmed to be fault-free.

- ▲ **Tips:** For products not within warranty period, our company can provide paid maintenance services. For products after paid repaired, the same performance problem will have a free warranty period within 3 months from the date of repairing.

(3) Metering Valve Out of Warranty Coverage

- ▲ The metering valve's warranty period has expired.
- ▲ Metering valve failure caused by high temperature, high pressure, humidity, rain and snow, saline-

alkali land, earthquake, and used in abnormal environment.

- ▲ Metering valve damage caused by man-made reasons (throwing, strong magnetic field magnetization, set fire).
- ▲ Metering valve failure or injector damage caused by non-metering valve's design, technology, manufacturing, quality, and other issues.
- ▲ Metering valve failure due to system pressure exceeding system approved pressure.
- ▲ Metering valve failure caused by impurities (water, lead, aluminum powder, iron powder, sulfide) in the system fuel exceeding the standard requirements.
- ▲ Metering valve failure caused by not installing according to the tightening torque specified in fuel pump maintenance manual (the tightening torque is too large or too small).
- ▲ Metering valve failure caused by not following the installation angle specified in fuel pump maintenance manual.
- ▲ Metering valve failure caused by not following the cleaning requirements specified in fuel pump maintenance manual.
- ▲ Metering valve failure caused by failure to replace consumable parts as specified in fuel pump maintenance manual.

1.8. 0928400605 Metering Valve Manufacturer

Metering Valve's Manufacturer: Shenzhen Shumatt Technology Co., Ltd

2. 0928400605 Metering Valve Technical Support

2.1. 0928400605 Metering Valve Technical Support Obtaining Methods

- (1) Metering Valve Technical File, visit <http://shumatt.com> to get the technical file.
- (2) Metering Valve Technical Videos

Facebook: Visit <https://www.facebook.com/hison.li> to get the technical videos, constantly follow can get more information.

YouTube: Visit https://www.youtube.com/channel/UCByvYBx7VjV_mAfxh_Hu-aw to get the technical videos, constantly follow can get more information.

Shumatt: Visit <http://shumatt.com> to get the technical videos.

- (3) Metering Valve Information Query Software

TruckBook Parts EPC APP, Android/Apple App Store download and install, visit <http://shumatt.com> to get the download and installation tutorial

- (4) Search Metering Valve test data through TruckBook Parts EPC APP.

3. 0928400605 Metering Valve Purchase and Delivery

3.1. 0928400605 Metering Valve Purchase Payment Terms

Payment Terms: T/T, PayPal, Alipay, WeChat

- ▲ Please contact our salesmen for specific payment information.

3.2. 0928400605 Metering Valve Main Sales Markets

Metering Unit Main Sales Markets: Asia, Europe, North America, South America, Africa etc.

3.3. 0928400605 Metering Valve Declaration Requirements

Shumatt can assist customers to provide the following documents for import customs clearance: contract, invoice, packing list, bill of lading, insurance policy, certificate of origin, etc.

3.4. 0928400605 Metering Valve Shipping Ways

Destination in China areas: SF Express, Debon Express, the corresponding logistics company can be provided according to customer requirements in special cases.

Destinations out of China’s areas: DHL, UPS, FedEx, TNT air, ocean or other shipping methods required by customers.

3.5. 0928400605 Metering Valve Lead time

Lead time: Send out within 3 – 7 working days after receiving payment (Except for special products and special cases).

3.6. 0928400605 Metering Valve Logistics Time for Destination Out of China’s Areas

DHL Logistics Time :

Country or Region of Departure	Hong Kong, China	Other Countries or Regions of Asia	Australia and New Zealand	Europe	America	Other Countries
China’s Mainland	7 Days	7 Days	8 Days	8 Days	8-12 Days	7-10 Days

UPS Logistics Time: Country or Region of Departure: China’s Mainland

Country of Destination	Estimated Arrival Time	Country of Destination	Estimated Arrival Time	Country of Destination	Estimated Arrival Time
Japan	3 Days	UK	5-7 Days	Egypt	5-7 Days
Turkey	5-7 Days	Singapore	3 Days	Switzerland	5-7 Days
Bahrain	5-7 Days	Latvia	7-10 Days	New Zealand	7-10 Days
Sri Lanka	5-7 Days	Thailand	3 Days	Austria	5-7 Days
Romania	5-7 Days	Vietnam	3-5 Days	Estonia	5-7 Days
Malaysia	3-5 Days	Israel	5-7 Days	Mexico	7-10 Days
France	5-7 Days	America	5-7 Days	United Arab Emirates	5-7 Days
Italy	5-7 Days	Netherlands	5-7 Days	Bengal	7-10 Days
Lebanon	5-7 Days	Philippine	3-5 Days	Greece	7-10 Days
South Korea	3 Days	Spain	5-7 Days	Myanmar	5-7 Days
Canada	5-7 Days	Germany	5-7 Days	Saudi Arabia	7-10 Days
Portugal	5-7 Days	Australia	5-7 Days	South Africa	7-10 Days
Denmark	5-7 Days	Belgium	5-7 Days	Ukraine	7-10 Days
India	7-10 Days	Qatar	7-10 Days	Poland	5-7 Days
Indonesia	3-5 Days	Morocco	7-10 Days	Pakistan	7-10 Days
Kuwait	7-10 Days	/	/	/	/

▲ The logistics time is for reference only, subjects are according to the actual arrival.

3.7. 0928400605 Metering Valve Packing

Domestic Express Packaging: Usually wrapped with waterproof scotch tape, such as picture No.1.

International Express Packaging: Wrapped with waterproof yellow tape After wrapping the black protective film, such as picture No. 2.

Pallet Shipping: Use fumigation free and recycling trays that meet export requirements, and use white

wrapping protective film to wrap and bind with cable ties for the outside, such as picture No. 3, Also, the products can be packaged according to customers' requirements.

- ▲ The packing tray is made of plastic and can be recycled.
- ▲ Transparent tape, yellow tape, black wrapping protective film, white wrapping protective film are non-degradable materials, please dispose of them properly.
- ▲ Minors are prohibited from using transparent tape, yellow tape, black wrapping protective film, and white wrapping protective film to avoid personal injury.



Pic No. 1

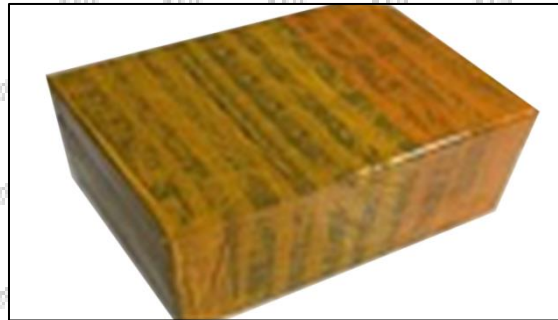

Pic No. 2

Domestic express packaging:

Wrapped by Transparent tape

International express packaging:

Wrapped with yellow tape after wrapping black protective film



Pic No. 3

Pallet Shipping: Use pallet that meet export requirements, and use white wrapping protective film to wrap and bind with cable ties

4. 0928400605 Metering Valve Storage Standard

(1) Choose a suitable storage place

The warehouse and cargo yard where metering valve is stored should be kept clean and dry, and away from the factory buildings that generate harmful gases and dust; do not mix with acid, alkali, salt, and other substances; the storage place should have a good drainage system; the cargo yard should be flattened with gravel or furnace ash etc. to enhance the water permeability of the surface layer to keep the reservoir area

dry.

(2) Strict requirements of warehousing

Strict inspections should be carried out when metering valves are put into storage, the surface cleaning work should be done well to remove water traces, oil stains, ash, and other dirt, remove the rust and do anti-rust treatment in time. The packed metering valves must be protected from being damaged.

(3) Keep the warehouse dry and preventing moisture

The relative humidity is usually below 70% for metering valves placed in the room, and the corrosion of metering valves is significantly reduced.

Metering valves must be stored in the warehouse, and they are forbidden to store in the same warehouse with commodities with high water content.

(4) Stack Properly

- ▲ After the metering valve is exposed in rain, the corrosion rate will increase significantly. The purpose of sealing is to isolate the metering valve from rainwater and humid air, so the warehouse window should be checked in time to avoid rainwater entering the warehouse.
- ▲ If metering valve package is damaged, it should be repaired or replaced; when the package is damp, the packaging material should be dried; if the original anti-corrosion and oil applied at the factory is found to be damaged or dried up, it should be cleaned and re-applied oil in time.
- ▲ It is forbidden to leave the metering valve exposed in the air for a long time.
- ▲ It is forbidden to store acid, alkali, salt, and other substances together with the metering valve.
- ▲ The unpacked metering valve must be rust-proof during secondary storage.

5. Company Information**5.1. Company Introduction**

Chinese Name: 深圳市舒马特科技有限公司

English Name: Shenzhen Shumatt Technology Co., Ltd.

☎ **Mob Phone/WeChat:** +86-13410541523

Mob/WhatsApp: +86 13410541523

Email : ruby@shumatt.com

© 2022 Shenzhen Shumatt Technology Co., Ltd

Tel: +8675523215133

Website : www.shumatt.com

 **HK Telephone:** +852-67653519

 **Telephone:** +86-755-23215133

 **Email:** ruby@shumatt.com

 **Website:** www.shumatt.net

Shenzhen Office: 11-12, Floor 14, Building 13, Qinchengda Building, Exit A, Honglang North Subway Station, Bao'an District, Shenzhen, China's Mainland

Shenzhen Office: Exit C, Qiao Touxu Metro Station, NO. 66 Chongqing Road, Fuhai Avenue, Bao'an District, Shenzhen, China Mainland

Hong Kong Office: Jianfa Street Industrial Zone, Tuen Mun, New Territories, Hong Kong, China

After-sales Service Address: Please contact our salesmen to obtain and provide the corresponding product maintenance reasons (Reference: [1.7. 0928400605 Metering Valve's Warranty Instructions.](#))

5.2. Sales-men's Contact Information

No.	Name	WeChat/WhatsApp	Email
1	Ruby	+86-13410541523	ruby@shumatt.com
2	Ivy	+86-18025299821	sales@shumatt.com
3	Rebecca	+86-18025349821	sales01@shumatt.com
4	Janny	+86-18028749821	sales02@shumatt.com
5	Sam	+86-13316859821	Sales8@shumatt.com
6	Natalie	+86- 18938945856	sales15@shumatt.com
7	Ada	+86-1342286353	sales5@shumatt.com
8	Hison Li	+86-18318811871	web@shumatt.com
9	Mecca	+86-18938948618	sales11@shumatt.com
10	Eric	+86 18319033618	sales3@shumatt.com
11	Wayne (Joaquín en español)	+86-13316959821	wayne@shumatt.com
12	Sylvia	+86 18312499884	sales6@shumatt.com

Visit <http://shumatt.com> to obtain the latest information of salesmen

PS: Shumatt's salesmen's emails are all end with **@shumatt.com**

6. Copyright Statement

The copyright of any contents (including but not limited to parameters, data, text, charts, images, sound, videos, etc.) provided in "**0928400605 Metering Valve Technical File**" belong to Shenzhen Shumatt Technology Co., Ltd. Without the prior written permission of Shenzhen Shumatt Technology Co., Ltd., you are not allowed to modify any contents in "**0928400605 Metering Valve Technical File**" in any way. At the same time, any conditions to spread, re-post, display the contents of "**0928400605 Metering Valve Technical File**" should indicate that the cited article is from Shenzhen Shumatt Technology Co., Ltd., Any actions failure to follow above conditions to use "**0928400605 Metering Valve Technical File**" will violate the "Copyright Law of the People's Republic of China" and other laws and regulations and the provisions of relevant international conventions.