

0445116018 Injector **CRI3-16** Technical File



SKU1: Y1Z200445116018

SKU2: Z1W20445116018

SKU3: Z1WL10445116018

SKU4: Y1W200445116018



## 0445116018 Injector **CRI3-16** Technical File

### Content

1. 0445116018 Injector Introduction .....	2
1.1. 0445116018 Injector Basic Information .....	2
1.2. 0445116018 Injector Common Part Number .....	2
1.3. 0445116018 Injector Matching Information .....	2
1.4. 0445116018 Injector Parameter .....	2
1.5. 0445116018 Injector Specifications and Dimensions .....	2
1.6. 0445116018 Injector Quality Control .....	3
1.7. 0445116018 Injector Customized Service .....	3
1.8. 0445116018 Injector Packing List and Package Size .....	4
1.9. 0445116018 Injector Testing Standard and Certificate .....	5
1.10. 0445116018 Injector Warranty Instructions .....	6
1.11. 0445116018 Injector Manufacturer .....	7
2. 0445116018 Injector Technical Support .....	7
2.1. 0445116018 Injector Part Number Location .....	7
2.2. 0445116018 Injector Application Scenarios .....	7
2.3. 0445116018 Injector Installation .....	8
2.4. 0445116018 Injector Reasons for Not Working Normally .....	8
2.5. 0445116018 Injector Causes of Being Damaged .....	9
2.6. 0445116018 Injector Technical Support Obtaining Methods .....	9
3. 0445116018 Injector Purchase and Delivery .....	10
3.1. 0445116018 Injector Purchase Payment Term .....	10
3.2. 0445116018 Injector Main Sales Markets .....	10
3.3. 0445116018 Injector Declaration Requirements .....	10
3.4. 0445116018 Injector Shipping Ways .....	10
3.5. 0445116018 Injector Lead time .....	10
3.6. 0445116018 Injector Logistics Time for Destination Out of China's Areas .....	10
3.7. 0445116018 Injector Packing .....	11
4. 0445116018 Injector Storage Standard .....	12
5. Company Information .....	13
5.1. Company Introduction .....	13
5.2. Salesmen's Contact Information .....	14
6. Copyright Statement .....	14

## 0445116018 Injector **CRI3-16** Technical File

### 1. 0445116018 Injector Introduction

#### 1.1. 0445116018 Injector Basic Information

Title	Common Rail 0445116018 Piezo Injector 0445116 Series <b>CRI3-16</b>	Quality
SKU 1	Y1Z200445116018	Original New
SKU 2	Z1W20445116018	Re-manufactured
SKU 3	Z1WL10445116018	Re-manufactured
SKU 4	Y1W200445116018	Original New

#### 1.2. 0445116018 Injector Common Part Number

##### (1) Injector Exchange Information

Injector Part Number	Universal Part Number	OE Number
0445116018	0445116017	0986435420

##### (2) Injector Application Information

Injector Part Number	Vehicle Brand	Car Model	OE Number
0445116018	HYUNDAI	Grand Santa Fe 2.2 CRDi 4WD	33800-2F000
	KIA	Carnival 2.2 CRDi	33800 2F000

##### (3) Injector Part Number Common Writing

0445116017, 0 445116017, 0 445 116017, 0 445 116 017, 0445 116017,0445116 018, 0445116018, 0 445116018, 0 445 116018, 0 445 116 018, 0445 116018, 0445116 018, 0 986 435 420, 33800-2F000

#### 1.3. 0445116018 Injector Matching Information

Vehicle Brand	Series	Car Model	Engine Model	Production Date	Power (KW)	Horse Power	Emission Standards	Manufacturer	Emissions (L)	Cylinder	Power Source (V)
HYUNDAI	Piezo	Grand Santa Fe 2.2 CRDi 4WD	D4HB	08/2013 -	145-147	197-200	/	NC	2.2	4	12
KIA	Piezo	Carnival 2.2 CRDi	D4HB	10/2009 - 12/2012	110	150	/	MB	2.2	4	12

#### 1.4. 0445116018 Injector Parameter

Adaptation System: **Common Rail System**

Injector Series: **Piezo Series**

Parameter Performance: **CRI3-18**

Injector Type: **Piezo Injector**

Support System Maximum Pressure: **1,800 bar**

#### 1.5. 0445116018 Injector Specifications and Dimensions

Injector Size: **21cm\*5cm \*5cm**

Injector Net Weight: **0.78kg**



**Injector Gross Weight:** 0.8kg  
**Injector Quality:** Original New/Re-manufactured  
**Injector Package Size:** 28cm\*7 cm \*7 cm  
**Injector Type:** Piezo Injector  
**Injector MOQ:** 4 Pieces

**1.6. 0445116018 Injector Quality Control**

**(1) Injector Testing**

All injector spare parts are tested for electrical characteristics, accuracy, high temperature, low temperature, withstand voltage, leakage, durability, and various working conditions.

**(2) Injector Assembling**





For the quality control of the injector production and installation process, our company strictly follows the standard product installation data and product installation steps to install, such as injector stroke test, injector solenoid valve tightening torque, injector nozzle tightening torque.

**(3) Injector Inspection**

The factory inspection of the injector is undergone full inspection, random inspection, and batch inspection three inspections. Different brands of test benches are used to test the same piezo injector for more than three times for factory inspection, and the piezo injector installation testing environment are progressed in dust-free workshop.

**1.7. 0445116018 Injector Customized Service**

**(1) Injector’s Customized Service Coverage:** Meet the customized needs of OEM manufacturers for shell lettering, logo engraving, injector internal packaging, injector external packaging and labels customized, etc.

			
Injector Nozzle Engraving	Injector House Lettering And QR Code	Injector Solenoid Engraving	Injector Box And Label

**(2) Injector’s Customized Service Requirements:**

The quantity of customized injectors shall not be less than **10 pieces**.









The quantity of customized injector packages shall not be less than **1000 pieces**.

Customized products involve the need of specify logo, the OEM manufacturer needs to provide trademark authorization and the sample of logo image file.

**▲ Once the customized piezo injector is sold, it cannot be returned or exchanged if there is no quality problem.**

1.8. 0445116018 Injector Packing List and Package Size

(1) Injector Spare Parts List

No.	1	2	3
Image			
Name	Piezo injector	O-Ring	Washer Shim
Description	Piezo injector part number: <b>0445116018</b>	Ensure to meet the standard of the sealing performance between the injector and the engine	Made of brass, used to ensure the tight fit between the injector cap end and the engine
No.	4	5	6
Image			
Name	Nozzle Protective Cover Cap	Injector House Protective Cover Cap	Solenoid Valve Protective Cap
Description	Protect nozzle holes from being polluted and blocked	Protect oil inlet from being polluted and blocked	Protect the solenoid valve body and terminals from being damaged by external forces
No.	7	8	9
Image			
Name	VCI Anti-rust Bag	Bubble Bag	Injector Packing Box
Description	Prevent piezo injector from rusting	Prevent the injector from being damaged by external forces	Place injector and injector accessories

▲ Minors are forbidden to use the piezo injector assembly, O-ring, gasket, nozzle protective cover, piezo injector house protective cover, solenoid valve protective cover, VCI anti-rust bag, and air bubble bag to avoid personal injury.

▲ O-ring and gasket are disposable installation accessories, and need to be replaced for re-installation.

▲ The nozzle protective cover, the injector house protective cover, and the solenoid valve protective cover are recyclable accessories that can be reused.

▲ VCI anti-rust bags and bubble bags are non-degradable materials, please dispose them properly after using.





## 1.10. 0445116018 Injector Warranty Instructions

### (1) Product Warranty Conditions and Instructions

It is necessary to provide pictures, videos, or test reports detected by the injector inspection equipment when the injector is abnormal during use as evidence to feed back to the salesman.

Abnormal conditions are properly explained such as: 1. Smoke, 2. Engine shake, 3. Difficulty starting the engine, 4. Engine noise, 5. oil leakage etc.

### (2) Injector Warranty Coverage

Within 15 days after customer receives the 0445116018 injector, if there is a performance failure and the product has no appearance damage, customer can choose to replace it or repair it;

If the 0445116018 injector has performance problems during the warranty period (6-12 months), and it is confirmed that it is product's problems after testing, you can contact our salesmen to replace the same model or a reworked product with the same performance for free;

If the injector house has obvious scratches, it can only be repaired and it will be returned as it is if the product is confirmed to be fault-free.

**▲ Tips: For products not covered by warranty, our company can provide paid maintenance services. For products after paid repaired, the same performance problem will have a free warranty period within 3 months from the date of repairing.**

### (3) Injector Out of Warranty Coverage

- The warranty period has expired.
- Injector failure caused by high temperature, high pressure, humidity, rain and snow, saline-alkali land, earthquake, and used in abnormal environment.
- Customer disassembles or repairs the injector personally resulting in damage to the injector.
- Injector damage caused by man-made reasons (throwing, strong magnetic field magnetization, set fire).
- Injector failure or injector damage caused by non-injector design, technology, manufacturing, quality, and other issues.
- Injector failure due to system pressure exceeding system approved pressure.
- Injector failure caused by system voltage exceeding approved voltage.
- Injector failure caused by impurities (water, lead, aluminum powder, iron powder, sulfide) in the system fuel exceeding the standard requirements.
- Injector failure caused by not installing according to the tightening torque specified in the vehicle engine maintenance manual (the tightening torque is too large or too small).
- Injector failure caused by not following the installation angle specified in the vehicle engine maintenance manual.
- Injector failure caused by not following the cleaning requirements specified in the vehicle engine maintenance manual.
- Injector failure caused by failure to replace consumable parts as specified in the vehicle engine maintenance manual.
- Injector failure caused by not complying with the intake system fit clearance and exhaust system fit clearance requirements specified in the vehicle engine maintenance manual.
- Failure to replace the consumable parts and the fitting clearance of the oil inlet system pipeline and the piezo injector connection in accordance with the fuel intake system specified in the vehicle engine maintenance manual.

**1.11. 0445116018 Injector Manufacturer**

Injector's Manufacturer: Shenzhen Shumatt Technology Co., Ltd

**2. 0445116018 Injector Technical Support**

**2.1. 0445116018 Injector Part Number Location**

1) E.g.: See the injector part number as follows

No.	Name
A	brand, logo, part number, series number
B	nozzle part number

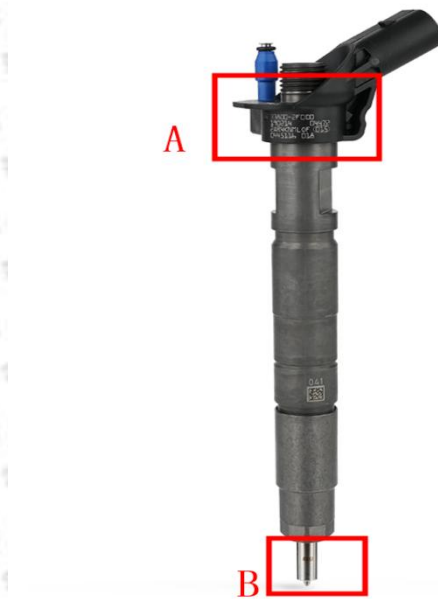

**2.2. 0445116018 Injector Application Scenarios**

Common rail system is an oil supply method refers to the diesel oil from the fuel tank sucked out by the gear pump through the oil-water separator and the gear pump to diesel fine filter, high-pressure pump, common rail pipe, and piezo injector, all together with the closed-loop fuel supply system composed of sensors and ECU that completely separates the generation of injection pressure and the injection process from each other.

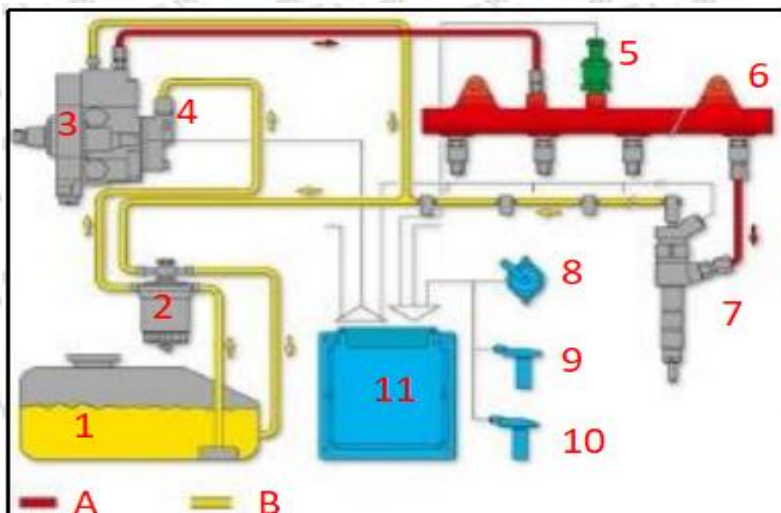



No.	Name	No.	Name	No.	Name	No.	Name
1	Tank	5	Common Rail Pressure Sensor	9	Engine Crankshaft Sensor	A	High Pressure Oil Circuit
2	Diesel Filter	6	Common Rail Pipe	10	Camshaft Sensor	B	Low Pressure Oil Circuit
3	High-Pressure Pump	7	Injector	11	ECU Electronic Control Unit	/	/
4	Fuel Gear Pump	8	Accelerator Pedal	/	/	/	/

### 2.3. 0445116018 Injector Installation

#### (1) 0445116018 Injector Installation Precautions:

- ▲ The replacement of the piezo injector must strictly follow the electrical system, the approved pressure of the low-pressure fuel intake system, the approved pressure of the high-pressure fuel circuit system, and fuel system replacement consumables requirements (including the low-pressure fuel circuit system filter and the high-pressure fuel circuit) specified in the vehicle engine maintenance manual.
- ▲ Replacement of wearing parts of the fuel system, cleaning requirements for the connection between the fuel system and the injector, the fitting clearance of the piezo injector connection, the installation angle and tightening torque of the injector, the fitting clearance of the intake system, and the fitting clearance of the exhaust system to ensure the service life of the engine and the normal operation of the injector.
- ▲ When installing the piezo injector on the engine, it is necessary to clean the engine block, cylinder head and other parts connected to the piezo injector, and ensure that there is no dust, carbon deposits, water, rust spots, etc.
- ▲ Before installing, check whether the piezo injector nozzle gasket has been replaced and installed on the piezo injector.
- ▲ When installing the piezo injector, apply lubricant between the piezo injector, fuel nozzle sealing gasket and O-ring.
- ▲ Without replacing new gasket can lead to: deformation of the tight cap of nozzle, deformation of nozzle, deformation of nozzle orifice, oil leakage and air leakage, which will cause serious damage to the piezo injector and nozzle to break and cause damage to the engine.
- ▲ When installing the injector on the engine, please carefully check the components related to the installation of the injector, such as the injector pressure plate, screw, injector rod and other accessories are not deformed, and install it in strict accordance with the operation steps of the engine maintenance manual.
- ▲ It is forbidden to operate the bare injector for a long time in an environment with serious dust pollution and corrosion to iron products.
- ▲ It is forbidden to operate the bare injector for a long time in a strong magnetic field environment.

### 2.4. 0445116018 Injector Reasons for Not Working Normally

- (1) There is air in the oil circuit of the engine fuel system.
- (2) Vehicle oil pump oil supply system is not normal.
- (3) Engine common rail system oil leakage or pressure limiting valve damage.
- (4) There is a short circuit, cutting out and poor contact in the wiring harness connected to the piezo injector of the vehicle.
- (5) The long-term placement of the injector causes the anti-rust oil to solidify, and the internal

components are stuck or the oil holes are blocked.

▲ Before installing, carefully check whether other components in the common rail system except the piezo injector are damaged to prevent the piezo injector from not working properly after being replaced.

## 2.5. 0445116018 Injector Causes of Being Damaged

- (1) Didn't operate properly according to engine maintenance manual during disassembly or installation, resulting in damage to the injector.
- (2) The fuel oil used for the vehicle does not meet the standard cause damage to the injector, such as: the water content in the fuel oil exceeds the standard, iron powder, aluminum powder, sulfide impurities exceed the standard, etc.
- (3) The engine is not regularly maintained according to the engine maintenance manual (please refer to the vehicle maintenance manual for the maintenance mileage). For example, failure to replace the lubricating oil of the engine system for a long time will cause abnormal wear of the engine, excessive exhaust gas volume or a large amount of carbon deposits inside the engine. The filter is not replaced during maintenance or the replaced filter cannot reach the original filter standard. all above reasons can cause damage to the injector.
- (4) The abrasion of the oil pump produces iron powder and aluminum powder enter the piezo injector and cause damage to the piezo injector.
- (5) The deformation and abrasion of fuel tank result in iron powder or aluminum powder entering the piezo injector and causing damage to the piezo injector.
- (6) The piezo injector is damaged due to replacement or adjustment of the relevant parts of the piezo injector. For example, the valve clearance does not meet the standard after the engine is repaired, the replacement or modification of the wiring harness connected to the injector fails to meet the original standard.
- (7) The engine is overheated and overloaded for a long-time working result in damage to the piezo injector.
- (8) The injector will be damaged naturally at the end of its working life.
- (9) The injector is magnetized (injector parts' magnetic exceeded) causing the injector to not work properly.

▲ Before replacing the piezo injector, please check the engine parts carefully according to the engine maintenance manual to avoid the piezo injector being damaged again after replacement.

## 2.6. 0445116018 Injector Technical Support Obtaining Methods

- (1) Injector Technical File , visit <http://shumatt.com> to get the technical file.
- (2) Injector Technical Videos

**Facebook:** Visit <https://www.facebook.com/hison.li> to get the technical videos, constantly follow can get more information.

**YouTube:** [https://www.youtube.com/channel/UCByvYBx7VjV\\_mAfxh\\_Hu-aw](https://www.youtube.com/channel/UCByvYBx7VjV_mAfxh_Hu-aw) to get the technical videos, constantly follow can get more information.

**Shumatt:** Visit <http://shumatt.com> to get the technical videos.

- (3) Injector Information Query Software

TruckBook Parts EPC APP, Android/Apple App Store download and install, visit <http://shumatt.com> to get the download and installation tutorial

- (4) Search The piezo injector test data through TruckBook Parts EPC APP.

**3. 0445116018 Injector Purchase and Delivery**

**3.1. 0445116018 Injector Purchase Payment Term**

**Payment Terms:** T/T, PayPal, Alipay, WeChat

**▲ Please contact our salesmen for specific payment information.**

**3.2. 0445116018 Injector Main Sales Markets**

Injector main sales markets: Asia, Europe, North America, South America, Africa etc.

**3.3. 0445116018 Injector Declaration Requirements**

Shumatt can assist customers to provide the following documents for import customs clearance: contract, invoice, packing list, bill of lading, insurance policy, certificate of origin, etc.

**3.4. 0445116018 Injector Shipping Ways**

**Destination in China Areas:** SF Express, Debon Express, the corresponding logistics company can be provided according to customer requirements in special cases.

**Destinations Out of China’s Areas:** DHL, UPS, FedEx, TNT air, ocean or other shipping methods required by customers.

**3.5. 0445116018 Injector Lead time**

**Lead time:** Send out within 3 – 7 working days after receiving payment ( Except for special products and special cases ) .

**3.6. 0445116018 Injector Logistics Time for Destination Out of China’s Areas**

**DHL Logistics Time :**

Country or Region of Departure	Hong Kong, China	Other Countries or Regions of Asia	Australia and New Zealand	Europe	America	Other Countries
China’s Mainland	7 Days	7 Days	8 Days	8 Days	8-12 Days	7-10 Days

**UPS Logistics Time: Country or Region of Departure: China’s Mainland**

**▲ The logistics time is for reference only, subjects are according to the actual arrival.**

Country of Destination	Estimated Arrival Time	Country of Destination	Estimated Arrival Time	Country of Destination	Estimated Arrival Time
Japan	3 Days	UK	5-7Days	Egypt	5-7 Days
Turkey	5-7 Days	Singapore	3 Days	Switzerland	5-7 Days
Bahrain	5-7 Days	Latvia	7-10 Days	New Zealand	7-10 Days
Sri Lanka	5-7 Days	Thailand	3 Days	Austria	5-7 Days
Romania	5-7 Days	Vietnam	3-5 Days	Estonia	5-7 Days
Malaysia	3-5 Days	Israel	5-7 Days	Mexico	7-10 Days
France	5-7 Days	America	5-7 Days	United Arab Emirates	5-7 Days



Italy	5-7 Days	Netherlands	5-7 Days	Bengal	7-10 Days
Lebanon	5-7 Days	Philippine	3-5 Days	Greece	7-10 Days
South Korea	3 Days	Spain	5-7 Days	Myanmar	5-7 Days
Canada	5-7 Days	Germany	5-7 Days	Saudi Arabia	7-10 Days
Portugal	5-7 Days	Australia	5-7 Days	South Africa	7-10 Days
Denmark	5-7 Days	Belgium	5-7 Days	Ukraine	7-10 Days
India	7-10 Days	Qatar	7-10 Days	Poland	5-7 Days
Indonesia	3-5 Days	Morocco	7-10 Days	Pakistan	7-10 Days
Kuwait	7-10 Days				

**3.7. 0445116018 Injector Packing**

**Domestic express packaging:** Usually wrapped in waterproof scotch tape, such as picture No.2.

**International express packaging :** Wrapped with waterproof yellow tape After wrapping the black protective film, such as picture No. 3.

**Pallet Shipping :** Use fumigation free and recycling trays that meet export requirements, and use white wrapping protective film to wrap and bind with cable ties for the outside, such as picture No. 4, also, the products can be packaged according to customers' requirements.

- ▲ The packing tray is made of plastic and can be recycled.
- ▲ Transparent tape, yellow tape, black wrapping protective film, white wrapping protective film are non-degradable materials, please dispose of them properly.
- ▲ Minors are prohibited from using transparent tape, yellow tape, black wrapping protective film, and white wrapping protective film to avoid personal injury.



Pic No. 2

**Domestic express packaging:**  
 Wrapped with Transparent tape



Pic No. 3

**International express packaging:**  
 Wrapped with yellow tape after wrapping black protective film



Pic No. 4

**Pallet Shipping:** Use pallet that meet export requirements, and use white wrapping protective film to wrap and bind with cable ties

#### 4. 0445116018 Injector Storage Standard

##### (1) Choose a suitable storage place

The warehouse and cargo yard where the piezo injector is stored should be kept clean and dry, and away from the factory buildings that generate harmful gases and dust; do not mix with acids, alkalis, salts and other substances; the storage place should have a good drainage system; the cargo yard should be flattened with gravel or furnace ash etc. to enhance the water permeability of the surface layer to keep the reservoir area dry.

##### (2) Strict requirements of warehousing

Strict inspections should be carried out when the piezo injectors are put into storage, the surface cleaning work should be done well to remove water traces, oil stains, ash, and other dirt, remove the rust and do anti-rust treatment in time. Packaged injectors must be protected from damage.

##### (3) Keep the warehouse dry and preventing moisture

The relative humidity is usually below 70% for the piezo injectors placed in the room, and the corrosion of the piezo injectors is significantly reduced.

Injectors must be stored in the warehouse, and they are forbidden to store in the same warehouse with commodities with high water content.

##### (4) Stack Properly

After the injector is exposed to rain, the corrosion rate will increase significantly. The purpose of sealing is to isolate the injector from rainwater and humid air, so the warehouse window should be checked in time to avoid rainwater entering the warehouse

If the piezo injector package is damaged, it should be repaired or replaced; when the package is damp, the packaging material should be dried; if the original anti-corrosion and oil applied at the factory is found to be damaged or dried up, it should be cleaned and re-applied oil in time.

▲ It is forbidden to leave the injector exposed in the air for a long time.

▲ It is forbidden to store acids, alkalis, salt, and other substances together with the injector.

 The unpacked piezo injector must be rust-proof during secondary storage.

## 5. Company Information





### 5.1. Company Introduction

**Chinese Name:** 深圳市舒马特科技有限公司

**English Name:** Shenzhen Shumatt Technology Co., Ltd

 **Mob Phone/WeChat:** +86-13410541523

 **HK Telephone:** +852-67653519

 **Telephone:** +86-755-23215133

 **Email:** [ruby@shumatt.com](mailto:ruby@shumatt.com)

 **Website:** [www.shumatt.com](http://www.shumatt.com)

 **Shenzhen Office:** 11-12, Floor 14, Building 13, Qinchengda Building, Exit A, Honglang North Subway Station, Bao'an District, Shenzhen, China's Mainland

 **Shenzhen Office:** Exit C, Qiao Touxu Metro Station, NO. 66 Chongqing Road, Fuhai Avenue, Bao'an District, Shenzhen, China Mainland

 **Hong Kong Office:** Jianfa Street Industrial Zone, Tuen Mun, New Territories, Hong Kong, China



📍 **After-sales Service Address :** Please contact our salesmen to obtain and provide the corresponding product maintenance reasons ( Reference: [1.10. 0445116018 Injector Warranty Instructions](#) )

## 5.2. Salesmen's Contact Information

No.	Name	WeChat/WhatsApp	Email
1	Ruby	+86-13410541523	ruby@shumatt.com
2	Ivy	+86-18025299821	sales@shumatt.com
3	Rebecca	+86-18025349821	sales01@shumatt.com
4	Janny	+86-18028749821	sales02@shumatt.com
5	Sam	+86-13316859821	Sales8@shumatt.com
6	Natalie	+86- 18938945856	sales15@shumatt.com
7	Ada	+86-1342286353	sales5@shumatt.com
8	Hison Li	+86-18318811871	web@shumatt.com
9	Mecca	+86-18938948618	sales11@shumatt.com
10	Eric	+86 18319033618	sales3@shumatt.com
11	Wayne ( Joaquín en español )	+86-13316959821	wayne@shumatt.com
12	Sylvia	+86 18312499884	sales6@shumatt.com

Visit <http://shumatt.com> to obtain the latest information of salesmen

**PS:** Shumatt's salesmen's emails are all end with **@shumatt.com**

## 6. Copyright Statement

The copyright of any contents (including but not limited to parameters, data, text, charts, images, sounds, or videos, etc.) provided in "0445116018 Injector CRI3-16 Technical File" belong to Shenzhen Shumatt Technology Co., Ltd. Without the prior written permission of Shenzhen Shumatt Technology Co., Ltd., you are not allowed to modify any contents in "0445116018 Injector CRI3-16 Technical File" in any way. At the same time, any conditions to spread, repost, display the contents of "0445116018 Injector CRI3-16 Technical File" should indicate that the cited article is from Shenzhen Shumatt Technology Co., Ltd., Any actions failure to follow above conditions to use "0445116018 Injector CRI3-16 Technical File" will violate the "Copyright Law of the People's Republic of China" and other laws and regulations and the provisions of relevant international conventions.